

REALTEK

NOT FOR PUBLIC RELEASE

RTL8196C-GR

IEEE 802.11n AP/ROUTER NETWORK PROCESSOR WITH EEE

PRELIMINARY DATASHEET
(CONFIDENTIAL: Development Partners Only)

Rev. 0.7
30 November 2009
Track ID: JATR-2265-11



Realtek Semiconductor Corp.

No. 2, Innovation Road II, Hsinchu Science Park, Hsinchu 300, Taiwan

Tel.: +886-3-578-0211. Fax: +886-3-577-6047

www.realtek.com

COPYRIGHT

©2009 Realtek Semiconductor Corp. All rights reserved. No part of this document may be reproduced, transmitted, transcribed, stored in a retrieval system, or translated into any language in any form or by any means without the written permission of Realtek Semiconductor Corp.

DISCLAIMER

Realtek provides this document “as is”, without warranty of any kind. Realtek may make improvements and/or changes in this document or in the product described in this document at any time. This document could include technical inaccuracies or typographical errors.

TRADEMARKS

Realtek is a trademark of Realtek Semiconductor Corporation. Other names mentioned in this document are trademarks/registered trademarks of their respective owners.

USING THIS DOCUMENT

This document provides detailed user guidelines to achieve the best performance when implementing the RTL8196C.

Though every effort has been made to ensure that this document is current and accurate, more information may have become available subsequent to the production of this guide.

REVISION HISTORY

Revision	Release Date	Summary
0.7	2009/11/30	Preliminary release.

Table of Contents

1. GENERAL DESCRIPTION	1
2. FEATURES	2
3. BLOCK DIAGRAM	4
4. PIN ASSIGNMENTS	5
4.1. PIN ASSIGNMENTS	5
4.2. PACKAGE IDENTIFICATION.....	5
5. PIN DESCRIPTIONS	6
5.1. RTL8196C CONFIGURATION UPON POWER ON STRAPPING	9
5.2. SHARED I/O PIN MAPPING	10
6. MEMORY CONTROLLER	11
6.1. SDRAM CONTROL INTERFACE.....	11
6.1.1. Features.....	11
6.2. NOR FLASH TYPE MEMORY	11
6.2.1. Features.....	11
6.2.2. Bank Address Mapping.....	12
6.2.3. Flash Command Sequence.....	12
6.3. SPI FLASH CONTROLLER	13
6.3.1. Features.....	13
6.4. SOFTWARE REGISTER DEFINITION	13
6.4.1. Memory Control Register (MCR) (0xB800_1000)	13
6.4.2. DRAM Configuration Register (DCR) (0xB800_1004).....	14
6.4.3. DRAM Timing Register (DTR) (0xB800_1008).....	15
6.4.4. NOR Flash Configuration Register (NFCR) (0xB800_1100).....	16
6.4.5. SPI Flash Configuration Register (SFCSR) (0xB800_1200).....	16
6.4.6. SPI Flash Configuration Register 2 (SFCSR2) (0xB800_1204).....	17
6.4.7. SPI Flash Control and Status Register (SFCSR) (0xB800_1208).....	18
6.4.8. SPI Flash Data Register (SFDR) (0xB800_120C)	18
6.4.9. SPI Flash Data Register 2 (SFDR2) (0xB800_1210).....	19
7. PERIPHERAL AND MISC CONTROL	20
7.1. GPIO CONTROL	20
7.1.1. GPIO Register Set (0xB800_3500).....	20
7.1.2. GPIO Port A, B, C, D Control Register (PABCD_CNR) (0xB800_3500).....	20
7.1.3. GPIO Port A, B, C, D Direction Register (PABCD_DIR) (0xB800_3508).....	20
7.1.4. Port A, B, C, D Data Register (PABCD_DAT) (0xB800_350C).....	21
7.1.5. Port A, B, C, D Interrupt Status Register (PABCD_ISR) (0xB800_3510).....	21
7.1.6. Port A, B Interrupt Mask Register (PAB_IMR) (0xB800_3514)	21
7.1.7. Port C, D Interrupt Mask Register (PCD_IMR) (0xB800_3518).....	22
7.2. GPIO SHARED PIN MAPPING LIST	22
8. GREEN ETHERNET	24
8.1. CABLE LENGTH POWER SAVING	24
8.2. LINK DOWN POWER SAVING.....	24
8.3. ENERGY EFFICIENT ETHERNET (EEE).....	24
9. DC SPECIFICATIONS	25
9.1. OPERATING CONDITIONS	25
9.2. POWER DISSIPATION	25

9.3.	SDRAM BUS DC PARAMETERS	26
9.4.	FLASH BUS DC PARAMETERS	26
9.5.	USB 1.1 DC PARAMETERS.....	27
9.6.	USB 2.0 DC PARAMETERS.....	27
9.7.	UART DC PARAMETERS	27
9.8.	GPIO DC PARAMETERS.....	28
9.9.	JTAG DC PARAMETERS	28
9.10.	LED DC PARAMETERS	28
10.	AC SPECIFICATIONS.....	29
10.1.	CLOCK SIGNAL TIMING.....	29
10.1.1.	SDRAM Clock Timing.....	30
10.2.	BUS SIGNAL TIMING	31
10.2.1.	SDRAM Bus	31
10.2.2.	Flash Bus	33
10.2.3.	Power Sequence.....	33
10.2.4.	Power Configuration Timing.....	34
11.	THERMAL CHARACTERISTICS	35
11.1.	THERMAL OPERATING RANGE	36
11.2.	RTL8196C THERMAL PARAMETERS.....	36
12.	MECHANICAL DIMENSIONS.....	37
12.1.	PLASTIC QUAD FLAT PACKAGE 128-PIN 14X20MM OUTLINE.....	37
13.	ORDERING INFORMATION	38

Realtek

CONFIDENTIAL

for ZTE CORPORATION

List of Tables

TABLE 1.	PIN DESCRIPTIONS	6
TABLE 2.	RTL8196C CONFIGURATION UPON POWER ON STRAPPING	9
TABLE 3.	SHARED I/O PIN MAPPING	10
TABLE 4.	MEMORY CONTROL REGISTER (MCR) (0xB800_1000)	13
TABLE 5.	DRAM CONFIGURATION REGISTER (DCR) (0xB800_1004)	14
TABLE 6.	DRAM TIMING REGISTER (DTR) (0xB800_1008)	15
TABLE 7.	NOR FLASH CONFIGURATION REGISTER (NFCR) (0xB800_1100)	16
TABLE 8.	SPI FLASH CONFIGURATION REGISTER (SFCR) (0xB800_1200)	16
TABLE 9.	SPI FLASH CONFIGURATION REGISTER 2 (SPCR2) (0xB800_1204)	17
TABLE 10.	SPI FLASH CONTROL AND STATUS REGISTER (SFCSR) (0xB800_1208)	18
TABLE 11.	SPI FLASH DATA REGISTER (SFDR) (0xB800_120C)	18
TABLE 12.	SPI FLASH DATA REGISTER 2 (SFDR2) (0xB800_1210)	19
TABLE 13.	GPIO REGISTER SET (0xB800_3500)	20
TABLE 14.	GPIO PORT A, B, C, D CONTROL REGISTER (PABCD_CNTR) (0xB800_3500)	20
TABLE 15.	GPIO PORT A, B, C, D DIRECTION REGISTER (PABCD_DIR) (0xB800_3508)	20
TABLE 16.	PORT A, B, C, D DATA REGISTER (PABCD_DAT) (0xB800_350C)	21
TABLE 17.	PORT A, B, C, D INTERRUPT STATUS REGISTER (PABCD_ISR) (0xB800_3510)	21
TABLE 18.	PORT A, B INTERRUPT MASK REGISTER (PAB_IMR) (0xB800_3514)	21
TABLE 19.	PORT C, D INTERRUPT MASK REGISTER (PCD_IMR) (0xB800_3518)	22
TABLE 20.	SHARED PIN REGISTER (PIN_MUX_SEL) (0xB800_0040)	22
TABLE 21.	OPERATING CONDITIONS	25
TABLE 22.	POWER DISSIPATION	25
TABLE 23.	SDRAM BUS DC PARAMETERS	26
TABLE 24.	FLASH BUS DC PARAMETERS	26
TABLE 25.	USB 1.1 DC PARAMETERS	27
TABLE 26.	USB 2.0 DC PARAMETERS	27
TABLE 27.	UART DC PARAMETERS	27
TABLE 28.	GPIO DC PARAMETERS	28
TABLE 29.	JTAG DC PARAMETERS	28
TABLE 30.	LED DC PARAMETERS	28
TABLE 31.	CLOCK SIGNAL TIMING	29
TABLE 32.	SDRAM CLOCK TIMING	30
TABLE 33.	SDRAM INPUT TIMING	31
TABLE 34.	SDRAM OUTPUT TIMING	31
TABLE 35.	SDRAM ACCESS CONTROL TIMING	32
TABLE 36.	FLASH ACCESS TIMING VALUES	33
TABLE 37.	POWER-UP TIMING PARAMETERS	33
TABLE 38.	THERMAL OPERATING RANGE	36
TABLE 39.	RTL8196C THERMAL PARAMETERS	36
TABLE 40.	ORDERING INFORMATION	38

List of Figures

FIGURE 1. BLOCK DIAGRAM	4
FIGURE 2. PIN ASSIGNMENTS	5
FIGURE 3. ONE 16-BIT, FOR 1M/2M/4M/8M BYTES FLASH CONFIGURATION.....	12
FIGURE 4. TYPICAL CONNECTION TO A CRYSTAL	29
FIGURE 5. TYPICAL CONNECTION TO AN OSCILLATOR.....	29
FIGURE 6. SDRAM CLOCK SPECIFICATIONS-1	30
FIGURE 7. SDRAM CLOCK SPECIFICATIONS-2	30
FIGURE 8. SDRAM INPUT TIMING	31
FIGURE 9. SDRAM OUTPUT TIMING	31
FIGURE 10. SDRAM ACCESS CONTROL TIMING.....	32
FIGURE 11. FLASH ACCESS TIMING	33
FIGURE 12. POWER UP SEQUENCE TIMING DIAGRAM	33
FIGURE 13. POWER UP CONFIGURATION TIMING DIAGRAM.....	34

Realtek
CONFIDENTIAL
for ZTE CORPORATION

1. General Description

The RTL8196C is an integrated System-on-a-Chip (SoC) Application Specific Integrated Circuit (ASIC) that implements a basic L2 5-port Ethernet switch and a high performance CPU. The embedded RISC CPU is an RLX4181, and the clock rate can be up to 400MHz. To improve computational performance, a 16-Kbyte I-Cache, 8-Kbyte D-Cache, 16-K I-MEM, and 8-Kbyte D-MEM are provided. A standard 5-signal P1149.1 compliant EJTAG test interface is supported for CPU testing and software development.

The RTL8196C provides five ports (from port 0 to port 4), integrated with five MAC and five physical layer transceivers for 10Base-T and 100Base-TX. Each port of the RTL8196C may be configured as a LAN or WAN port.

The RTL8196C supports flexible IEEE 802.3x full-duplex flow control and optional half-duplex backpressure control. For full-duplex, standard IEEE 803.3x flow control will enable pause ability only when both sides of UTP have auto-negotiation ability and have enabled pause ability. The RTL8196C also provides optional forced mode IEEE 802.3x full-duplex flow control. Based on optimized packet memory management, the RTL8196C is capable of Head-Of-Line blocking prevention.

L2 Switch Features: The RTL8196C contains a 1024-entry address look-up table with a 10-bit 4-way XOR hashing algorithm for address searching and learning. Auto aging of each entry is provided and the aging time is 300~450 seconds.

The RTL8196C supports IEEE 802.3az Draft 2.0, also known as Energy Efficient Ethernet (EEE). IEEE 802.3az operates with the IEEE 802.3 Media Access Control (MAC) Sublayer to support operation in Low Power Idle mode. When the Ethernet network is in low link utilization, EEE allows systems on both sides of the link to save power. Green Ethernet power saving provides: link-on and dynamic detection of cable length, and dynamic adjustment of power required for the detected cable length. This feature provides high performance with minimum power consumption. The RTL8196C also implements link-down power saving on a per-port basis, greatly cutting power consumption when the network cable is disconnected.

For peripheral interfaces, one 16550-compatible UART is supported, and a 16-byte FIFO buffer is provided. A USB 2.0 host controller is embedded in the RTL8196C to provide EHCI and OHCI 1.1 compliant host functionality. A USB PHY is also embedded in the RTL8196C.

An MDI/MDIX auto-crossover function is supported. For accessing high-speed devices, the RTL8196C provides a PCI Express bridge to access a PCI Express interface.

The RTL8196C requires only a single 25MHz crystal or 40MHz clock input for the system PLL. The RTL8196C also has two hardware timers and one watchdog timer to provide accurate timing and watchdog functionality. For extension and flexibility, the RTL8196C has up to 17 GPIO pins.

The RTL8196C is provided in a PQFP 128-pin package. It requires only a 3.3V and 1.0V external power supply.

2. Features

- SOC
 - ◆ Embedded RISC CPU, RLX4181 with 16K I-Cache, 8K D-Cache, 16K I-MEM, 8K D-MEM
 - ◆ Supports MIPS-1 ISA, MIPS16 ISA
 - ◆ Clock rate up to 400MHz
 - ◆ Provides a standard 5-signal P1149.1 EJTAG test port
 - ◆ Supports RLX4181 CPU suspend mode
- L2 Capabilities
 - ◆ Five Ethernet MAC integrated switch with five 10M/100Mbps physical layers and transceivers for IEEE 802.3 10Base-T and 100Base-TX
 - ◆ Non-blocking wire-speed reception and transmission and non-head-of-line-blocking/forwarding
 - ◆ Internal 512Kbit SRAM for packet buffering
 - ◆ Internal 1024 entry 4-way hash L2 look-up table
 - ◆ Supports source and destination MAC address filtering
 - ◆ Supports IEEE 802.1x port-based and MAC-based Network Access Control
 - ◆ Complies with IEEE 802.3/802.3u/802.1q/802.1d
 - ◆ Flexible full-duplex 802.3x flow control and optional half-duplex backpressure flow control
 - ◆ MAC learning supports Shared VLAN Learning (SVL) and Independent VLAN Learning (IVL) modes
- CPU Interface (NIC)
 - ◆ Supports BSD mbuf-like packet structure with adjustable cluster size (128-byte to 2Kbyte) to provide optimum memory utilization
 - ◆ Provides the 'To-CPU reason' in the packet header to facilitate packet processing
 - ◆ The NIC DMA supports multiple-descriptor-ring architecture for QoS applications (supports 6 RX descriptor rings and 2 TX descriptor rings)
- Peripheral Interfaces
 - ◆ Supports one PCI Express Host with integrated PHY
 - ◆ Supports one 16550 UART
 - ◆ Supports up to 17 GPIO pins
 - ◆ Supports one-port USB 2.0 host interface
 - ◆ Embedded USB PHY
- Memory Interfaces
 - ◆ Flash (NOR Type)
 - Supports two Flash banks that can be configured as 8/16-bit bus, 256k/512k/1M/2M/4M/8M bytes
 - System supports up to 16Mbyte Flash memory space
 - Boot up from NOR Flash is supported
 - ◆ Flash (SPI Type)
 - Supports 4 channels for SPI Flash application
 - Boot up from SPI Flash is supported
 - System supports up to 32Mbyte Flash memory space

- ◆ SDRAM
 - Supports two SDRAM banks that can be configured as 2M/4M/8M/16M/32M/64Mbyte
 - 16-bit SDRAM data bus is supported. System totally supports up to 128Mbyte SDRAM memory space
- Supports Green Ethernet
 - ◆ Cable length power saving
 - ◆ Power down power saving
- ◆ Supports IEEE 802.3az Draft 2.0 Energy Efficient Ethernet (EEE) for 100Base-TX in full duplex operation, and 10Base-T in full/half duplex mode
- Other Add-on-Value Features
 - ◆ Supports Link down power saving in Ethernet PHY
 - ◆ Supports two hardware timers and one watchdog timer
 - ◆ Per-port configurable auto-crossover function
 - ◆ Single 25MHz crystal or 40MHz clock input
 - ◆ PQFP 128-pin package

Realtek
CONFIDENTIAL
for ZTE CORPORATION

3. Block Diagram

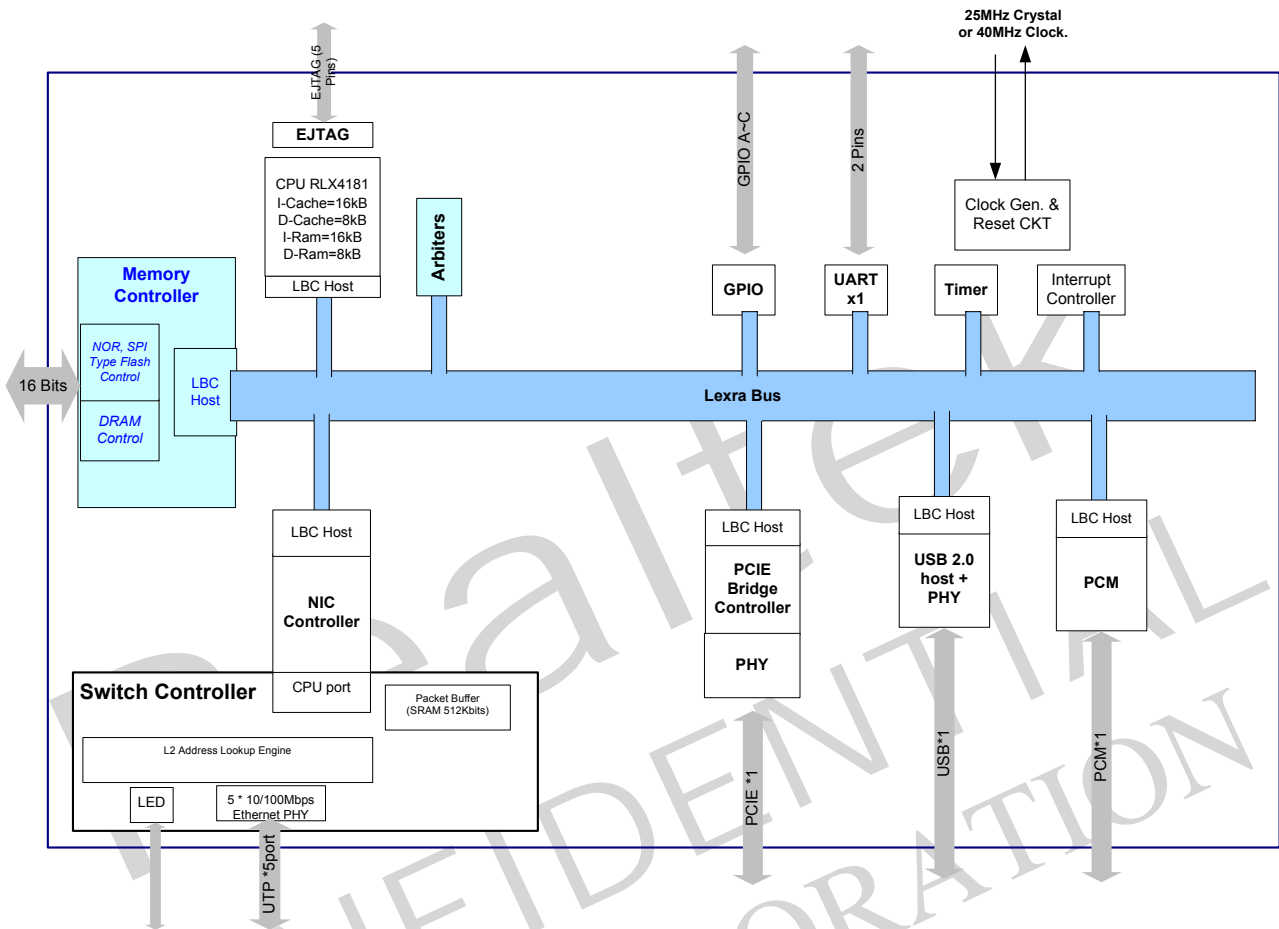

Figure 1. Block Diagram

4. Pin Assignments

4.1. Pin Assignments

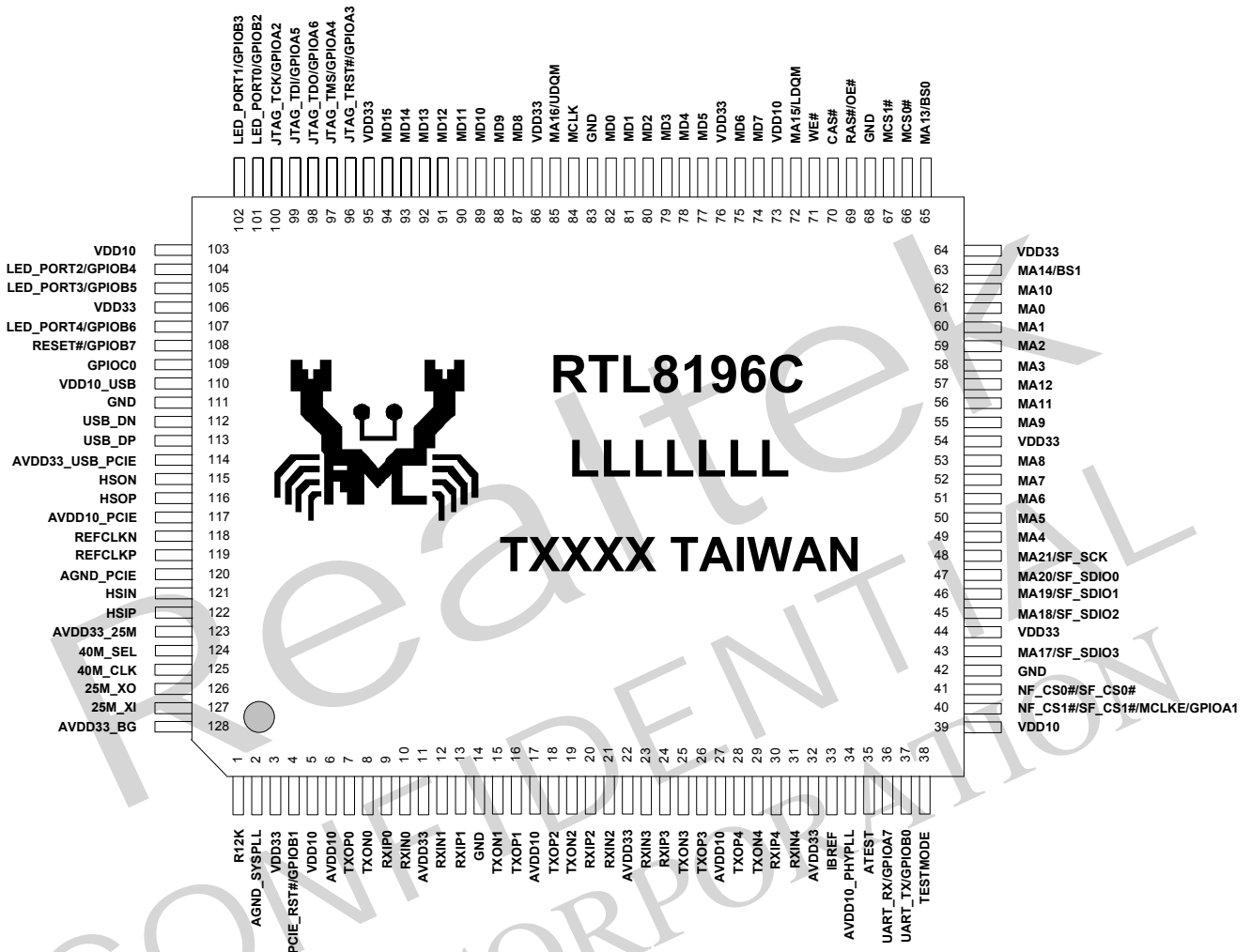

Figure 2. Pin Assignments

4.2. Package Identification

Green package is indicated by a 'G' in the location marked 'T' in Figure 2.

5. Pin Descriptions

In this section the following abbreviations are used:

I: Input	AI: Analog Input
O: Output	AO: Analog Output
IO: Bi-Directional Input/Output	AI/O: Analog Bi-Directional Input/Output
P: Digital Power	AP: Analog Power
G: Digital Ground	AG: Analog Ground
T/S: Tri-State Bi-Directional Input/Output	S/T/S: Sustained Tri-State
I _{PD} : Input Pin With Pull-Down Resistor	O _{OD} : Output With Open Drain
I _{PU} : Input Pin With Pull-Up Resistor; (Typical Value = 75K Ohm)	O _{3S} : Output With Tri-State

Table 1. Pin Descriptions

Pin Name	Pin No.	Type	Description
Clock & Reset			
25M_XI	127	I	25MHz Crystal Clock Input
25M_XO	126	O	25MHz Crystal Clock Output
40M_CLK	125	I	40MHz Clock Input V _{peak-to-peak} 1.4 Voltage
40M_SEL	124	I	System Clock Source Select. 0: 25MHz 1: 40MHz
RESET#	108	I	The System Reset Active Low
10M/100Mbps Physical Layer			
TXOP[4:0] TXON[4:0]	28, 26, 18, 16, 7 29, 25, 19, 15, 8	AO	10/100M Ethernet Physical Layer Transmit Pair. For differential data transmission
RXIP[4:0] RXIN[4:0]	30, 24, 20, 13, 9 31, 23, 21, 12, 8	AI	10/100M Ethernet Physical Layer Receive Pair. For differential data reception
Memory Bus			
MD[15:0]	94, 93, 92, 91, 90, 89, 88, 87, 74, 75, 77, 78, 79, 80, 81, 82	I/O	Data for SDRAM and NOR Type Flash
MA[21:0]	48, 47, 46, 45, 43, 85, 72, 63, 65, 57, 56, 62, 55, 53, 52, 51, 50, 49, 58, 59, 60, 61	O	Address for SDRAM and NOR Type Flash. Shared pins: MA[13]: SDRAM BS0 MA[14]: SDRAM BS1 MA[15]: SDRAM LDQM MA[16]: SDRAM UDQM MA[17]: SPI Flash SDIO3 MA[18]: SPI Flash SDIO2 MA[19]: SPI Flash SDIO1 MA[20]: SPI Flash SDIO0 MA[21]: SPI Flash SCK

Pin Name	Pin No.	Type	Description
SDRAM Control			
MCLK	84	O	SDRAM Clock
MCLKE	40	O	SDRAM Clock Enable
MCS0#	66	O	SDRAM Bank 0 Chip Select
MCS1#	67	O	SDRAM Bank 1 Chip Select
BS[1:0]	63, 65	O	SDRAM Chip Bank Select [1:0] Shared with A[14:13]
RAS#	69	O	Raw Address Strobe for SDRAM
CAS#	70	O	Column Address Strobe for SDRAM
WE#	71	O	Write Enable for SDRAM
LDQM	72	O	Lower Data Mask Output to SDRAM Corresponds to D[7:0] Pin shared with A[15]
UDQM	85	O	Upper Data Mask Output to SDRAM Corresponds to D[15:8] Pin shared with A[16]
NOR Type Flash Control			
NF_CS0#	41	O	ROM Bank 0 Chip Select for NOR Type Flash Memory
NF_CS1#	40	O	ROM Bank 0 Chip Select for NOR Type Flash Memory
OE#	69	O	Output Enable (OE#) for NOR Type Flash. Pin shared with SDRAM RAS#
WE#	71	O	Write Enable for NOR Type Flash. Pin shared with SDRAM WE#
SPI Serial Flash Control			
SF_CS0#	41	O	SPI Serial Flash Chip Select 0 Pin shared with NOF_CS0#
SF_CS1#	40	O	SPI Serial Flash Chip Select 1 Pin shared with NOF_CS1#
SF_SDIO[3:0]	43, 45, 46, 47	I/O	SPI Serial Flash Serial Data Input/Output
SF_SCK	48	O	SPI Serial Flash Serial Clock Output The SF_SDI will be driven on the falling edge The SF_SDO will be latched on the rising edge
UART			
UART_TX	37	O	UART Data Transmit Serial Output
UART_RX	36	I _{PD}	UART Data Receive Serial Input
JTAG			
JTAG_TCK	100	I _{PU}	JTAG Test Clock
JTAG_TMS	97	I _{PU}	JTAG Test Mode Select
JTAG_TDO	98	O	JTAG Test Data Output
JTAG_TDI	99	I _{PU}	JTAG Test Data In
JTAG_TRST#	96	I _{PU}	JTAG Test Reset
LED			
LED_PORT[4:0]	107, 105, 104, 102, 101	O	Link/Activity Status of 5 Ethernet Ports
GPIO			
GPIOA[7:0]	36, 98, 99, 97, 96, 100, 40, 67	I/O	GPIO Port A

Pin Name	Pin No.	Type	Description
GPIOB[7:0]	108, 107, 105, 104, 102, 101, 4, 37	I/O	GPIO Port B
GPIOC0	109	O	GPIO Port C
PCI Express Interface			
HS0N HS0P	115 116	AO	Transmitter Differential Pair
HS1N HS1P	121 122	AI	Receiver Differential Pair
REFCLKN REFCLKP	118 119	AO	Reference Clock Differential Pair
PCIE_RST#	4	O	PCI Express Reset Active Low
USB2.0			
USB_DP	113	AI/O	USB Device Data Plus Pin
USB_DN	112	AI/O	USB Device Data Minus Pin
Test			
TESETMODE	38	I _{PD}	For Chip Internal Test 1: Test Mode 0: Normal Mode
Reference Voltage			
IBREF	33	AI	Reference Voltage for Ethernet PHY 2.5K 1% pull down
R12K	1	AI	Reference Voltage for System 12K 1% pull down
Power & GND			
VDD33	3, 44, 54, 64, 76, 86, 95, 106	P	Digital I/O Power Supply 3.3V
AVDD33	11, 22, 32	AP	Ethernet Analog Power Supply 3.3V
VDD10	5, 39, 73, 103	P	Digital Core Power Supply 1.0V
AVDD10	6, 17, 27	AP	Ethernet Analog Power Supply 1.0V
AVDD33_X25M	123	AP	25M Crystal Power 3.3V
AVDD33_BG	128	AP	System Bandgap Power Supply 3.3V
AVDD10_PCIE	117	AP	PCI Express Analog Power Supply 1.0V
AVDD10_PHYPLL	34	AP	Ethernet PHY PLL Power 1.0V
AVDD33_USB_PCIE	114	AP	USB2.0 and PCI Express Analog Power 3.3V
AVDD10_USB	110	AP	USB2.0 Analog Power 1.0V
GND	14, 42, 68, 83, 111	G	System GND
AGND_SYSPLL	2	AG	System PLL GND
AGND_PCIE	120	AG	PCI Express GND

5.1. RTL8196C Configuration Upon Power On Strapping

All mode configuration pins are internal pull low. The 1.0V digital core power input pin voltage is up to 0.7V on system power-on. The strap data will be latched after a delay of 300ms.

Table 2. RTL8196C Configuration Upon Power On Strapping

H/W Pin Name	Configuration Name	Pin No	Description
MA11, MA10, MA9	ck_cpu_freq_sel[2:0]	56, 62, 55	CPU Clock Configuration 000: 250MHz 001: 270MHz 010: 290MHz 011: 310MHz 100: 330MHz 101: 350MHz 110: 370MHz 111: 390MHz
MA8, MA7, MA6	ck_freq_sel[2:0]	53, 52, 51	SDRAM Clock Rate Configuration 000: 65.625MHz 001: 78.125MHz 010: 125MHz 011: 150MHz 100: 156.25MHz 101: 168.75MHz 110: 193.75MHz 111: Reserved
MA5	Sync_lx_oc	50	Selection for Internal Bus Test Mode This is a hardware strapping pin. 0: Normal mode 1: Test mode
MA2	EnOLTautoTestMode	59	Enable Operational Level Test (OLT) Auto Test Mode 0: Normal mode 1: Test mode
MA1	BOOTSEL	60	Boot Device Select for Flash Booting 0: Boot from NOR-type Flash (default) 1: Boot from Serial Flash (SPI)
MA3	Clklx_from_clkm	58	Internal Local Bus Source 0: 200MHz 1: From memory clock
MA4	ENABLE_EXT_RSTN	49	External Reset 0: Disable chip RESET function; Pin 108 can be used as a GPIO or DBG pin 1: Enable chip RESET function
MA12	ck_cpu_div_sel	57	PLL Clock for CPU 0: CPU PLL clock is not divided by 2 1: CPU PLL clock is divided by 2
MA13	en_router_mode	65	Router or AP Mode Select 0: AP mode (Turns-off Ethernet Switch and Port 0 to Port 3 PHY circuit for power-saving) 1: Router mode (All Ethernet Ports are working)
MA14	swap_dbg_halfword	63	Internal Debug Mode Select

5.2. Shared I/O Pin Mapping

Table 3. Shared I/O Pin Mapping

Pin No.	GPIO	EJTAG	LED	UART	Reset	Memory
67	GPIOA[0]	-	-	-	-	MCS1#
40	GPIOA[1]	-	-	-	-	NF_CS1# SF_CS1# MCLKE
100	GPIOA[2]	JTAG_TCK	-	-	-	-
96	GPIOA[3]	JTAG_TRST#	-	-	-	-
97	GPIOA[4]	JTAG_TMS	-	-	-	-
99	GPIOA[5]	JTAG_TDI	-	-	-	-
98	GPIOA[6]	JTAG_TDO	-	-	-	-
36	GPIOA[7]	-	-	UART_RX	-	-
37	GPIOB[0]	-	-	UART_TX	-	-
4	GPIOB[1]	-	-	-	PCIE_RST#	-
101	GPIOB[2]	-	LED_PORT0	-	-	-
102	GPIOB[3]	-	LED_PORT1	-	-	-
104	GPIOB[4]	-	LED_PORT2	-	-	-
105	GPIOB[5]	-	LED_PORT3	-	-	-
107	GPIOB[6]	-	LED_PORT4	-	-	-
108	GPIOB[7]	-	-	-	RESET#	-
109	GPIOC[0]	-	-	-	-	-

6. Memory Controller

The RTL8196C integrates a memory control module to access external SDRAM and Flash memory.

The interface is designed for PC133 or PC166-compliant SDRAM, and supports auto-refresh mode, which requires a 4096 refresh cycle within 64ms, and the SDRAM size and timing is configurable in registers.

The RTL8196C also supports one flash memory chip (NF_CS0#). The interface supports 8/16-bit NOR-type flash memory. When NOR type is used, the system will boot from KSEG1 at virtual address 0xBFC0_0000 (physical address: 0x1FC0_0000). The flash size is configurable from 1M to 8M bytes for each chip. If the flash size is set to 4M or 8M bytes, 0xBFC0_0000 still maps the first 4M bytes of flash, and there will be a new memory mapping from 0xBD00_0000 (0xBD00_0000 maps to chip 0 byte 0).

6.1. SDRAM Control Interface

PC100~PC166-compliant SDRAM is supported. The SDRAM controller supports Auto Refresh mode, which requires a 4096-cycle refresh each 64ms. The RTL8196C provides a maximum of 512Mbit address space (8Mx16x4Banks) and the SDRAM size is configurable.

6.1.1. Features

- Interface (Bus Width): 16-bit
- Targeted SDR Frequency: Up to 166MHz
- Supported SDR SDRAM Chip Specification:
 - Bank Counts: 2, 4
 - Row Counts: 2K (A0~A10), 4K (A0~A11), 8K (A0~A12)
 - Column Counts: 256 (A0~A7), 512 (A0~A8), 1K (A0~A9), 2K (A0~A9, A11)

6.2. NOR Flash Type Memory

6.2.1. Features

- Interface (Bus Width): 8-bit/16-bit
- Supports NOR Flash Chip Specification:
 - 8-bit: 256Kbyte, 512Kbyte, 1Mbyte, 2Mbyte, 4Mbyte
 - 16-bit: 512Kbyte, 1Mbyte, 2Mbyte, 4Mbyte, 8Mbyte

6.2.2. Bank Address Mapping

The flash controller supports boot sector flash memory and the system always boots from bank0. The boot bank (bank 0) is mapped to KSEG1 with the start physical address of 0x1E00.0000 (virtual address: 0xBD00.0000). Bank0 is also mapped to the start physical address of 0x1FC0.0000.

The system always boots up from bank 0. For software, it is suggested that the program jumps to the space [0x1E00.0000~0x1EFF.FFFF] for a larger continuous space after booting up from 0x1FC0.0000. However, for backward compatibility, the program can choose to stay in the 4MByte space [0x1FC0.0000~0x1FFF.FFFF].

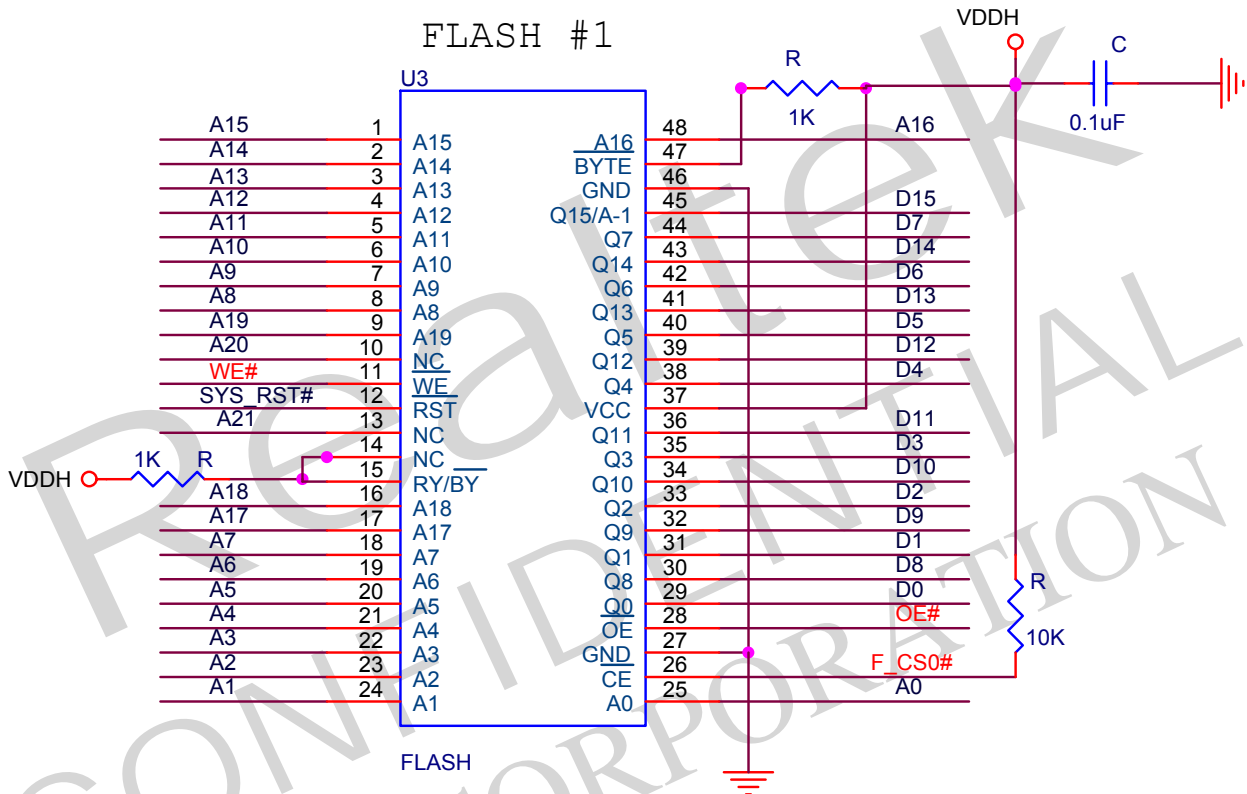

Figure 3. One 16-bit, for 1M/2M/4M/8M Bytes Flash Configuration

6.2.3. Flash Command Sequence

Directly write or read the target Flash address following the command sequence specified in the flash memory provider's datasheet. However, programmers must pay attention to the following:

- Use 16-bit (half-word) manipulation. Byte or full word manipulation will cause unpredictable errors
- The Program address is the address defined for the Flash
- The Command address is 0xBFC0.0000 + command address * 2
- Program data/Command data. The data may be placed in either the lower half-word or upper half-word position in a 32-bit full word. It depends on the least significant two bits of the accessed address

6.4.2. DRAM Configuration Register (DCR) (0xB800_1004)

This register does not provide byte access.

Table 5. DRAM Configuration Register (DCR) (0xB800_1004)

Bit	Name	Description	Mode	Default
31:30	T_CAS	CAS Latency 00: Latency=2 01: Latency=3 10: Latency=2.5 11: Reserved	RW	01B
29:28	DBUSWID	DRAM Bus Width 00: Reserved 01: 16-bit 10: Reserved 11: Reserved	RW	01B
27	DCHIPSEL	DRAM Chip Select 0: Test mode 1: Normal mode	RW	1B
26:25	ROWCNT	Row Counts 00: 2K (A0~A10) 01: 4K (A0~A11) 10: 8K (A0~A12) 11: 16K (A0~A13)	RW	00B
24:22	COLCNT	Column Counts 000: 256 (A0~A7) 001: 512 (A0~A8) 010: 1K (A0~A9) 011: 2K (A0~A9, A11) 100: 4K (A0~A9, A11, A12) 101: Reserved 110: Reserved 111: Reserved	RW	000B
21	BSTREF	Bursted 8 Auto-Refresh Commands (Used for DDR) 0: Disable 1: Enable	RW	0B
20	ARBIT	Enforce Interface Arbitration to Take Effect 0: Reserved 1: Take effect	RW	0B
19	BANKCNT	Bank Counts 0: 2 banks (used for SDR) 1: 4 banks (used for SDR, DDR)	RW	1B
18	FAST_RX	If RX path turnaround delay is small enough, the memory controller can return read data with reduced latency within 1DRAM clock cycle (used for DDR). 0: Normal path 1: Fast path	RW	0B
17	MR_MODE	Select the Memory Command that the Memory Controller Issues (Used for DDR) 0: Mode Register 1: Extended Mode Register	RW	0B
16	DRV_STR	Drive Strength Setting of DRAM Chip (Used for DDR) For this option to be effective, MR_MODE must be first set to 1. 0: Normal 1: Reduced	RW	0B
15:0	Reserved	Reserved	-	-

6.4.3. DRAM Timing Register (DTR) (0xB800_1008)

This register does not provide byte access.

Table 6. DRAM Timing Register (DTR) (0xB800_1008)

Bit	Name	Description	Mode	Default
31:29	T_RP	tRP Timing Parameter of DRAM Basic unit = 1* DRAM_CLK 000 means 1 unit	RW	111B
28:26	T_RCD	tRCD Timing Parameter of DRAM Basic unit = 1* DRAM_CLK 000 means 1 unit	RW	111B
25:21	T_RAS	Minimum T_RAS Timing Parameter of DRAM Basic unit = 1* DRAM_CLK 00000 means 1 unit	RW	11111B
20:16	T_RFC	tRFC Timing Parameter of DRAM Refresh row cycle time Basic unit = 1* DRAM_CLK 00000 means 1 unit	RW	11111B
15:12	T_REFI	tREF Timing Parameter of DRAM Refresh row interval time Basic unit = T_REFI_UNIT 0000: 1 unit 0001: 2 units ... 1111: 16 units	RW	0000B
11:9	T_REFI_UNIT	Basic Unit of T_REFI 000: 32 DRAM_CLK 001: 64 DRAM_CLK 010: 128 DRAM_CLK 011: 256 DRAM_CLK 100: 512 DRAM_CLK 101: 1024 DRAM_CLK 110: 2048 DRAM_CLK 111: 4096 DRAM_CLK	RW	111B
8:6	T_WR	tWR Timing Parameter of DRAM Write recovery time Basic unit = 1* DRAM_CLK 000 means 1 unit	RW	111B
5:0	Reserved	Reserved	-	-

6.4.4. NOR Flash Configuration Register (NFCR) (0xB800_1100)

This register does not provide byte access.

Table 7. NOR Flash Configuration Register (NFCR) (0xB800_1100)

Bit	Name	Description	Mode	Default
31:28	T_CEPL	The Timing Interval for CE# to be Pulled-Low before WE#/OE# is Pulled-Low Basic Unit = 1 * DRAM clock cycle 0000 means 1 unit	RW	1111B
27:23	T_WEOEPL	The Timing Interval for WE#/OE# to be Pulled-Low Basic Unit = 1 * DRAM clock cycle 00000 means 1 unit	RW	11111B
22:19	T_RDOZ	The Timing Interval for OE# to be Pulled-High before Read-Data Output High-Z Basic Unit = 1 * DRAM clock cycle 0000 means 1 unit	RW	1111B
18:16	NFSIZE	NOR Flash Size 000: 256Kbyte 001: 512Kbyte 010: 1Mbyte 011: 2Mbyte 100: 4Mbyte 101: 8Mbyte 110: Reserved 111: Reserved	RW	110B
15	NBUSW	NOR Flash Bus Width 0: 8-bit 1: 16-bit	R	1B
14:0	Reserved	Reserved	-	-

6.4.5. SPI Flash Configuration Register (SFCR) (0xB800_1200)

This register does not provide byte access.

Table 8. SPI Flash Configuration Register (SFCR) (0xB800_1200)

Bit	Name	Description	Mode	Default
31:29	SPI_CLK_DIV	SPI Operating Clock Rate Selection The value defines the divisor to generate the SPI clock. SPI Clock = (SDRAM Clock) / (SPI_CLK_DIV) 000: DIV = 2 001: DIV = 4 010: DIV = 6 011: DIV = 8 100: DIV = 10 101: DIV = 12 110: DIV = 14 111: DIV = 16	RW	111B
28	RBO	Serial Flash Read Byte Ordering 0: The byte order is from low to high 1: The byte order is from high to low	RW	1B
27	WBO	Serial Flash Write Byte Ordering 0: The byte order is from low to high 1: The byte order is from high to low	RW	1B
26:23	SPI_TCS	SPI Chip Deselect Time Basic unit = 1 * DRAM clock cycle 0000 means 1 unit, 0001 means 2 units, etc.	RW	1111B
22:0	Reserved	Reserved	-	-

6.4.6. SPI Flash Configuration Register 2 (SFCR2) (0xB800_1204)

This register does not provide byte access.

Table 9. SPI Flash Configuration Register 2 (SPCR2) (0xB800_1204)

Bit	Name	Description	Mode	Default
31:24	SFCMD	SPI Flash 8-Bit Command Code of a Read Transaction Example: 'Read Data' is 0x03. 'Fast Read' is 0x0B.	RW	0x03H
23:21	SFSIZE	SPI Flash Size 000: 128Kbytes 001: 256Kbytes 010: 512Kbytes 011: 1Mbytes 100: 2Mbytes 101: 4Mbytes 110: 8Mbytes 111: 16Mbytes	RW	111B
20	RD_OPT	SPI Flash Sequential Access Optimization 0: No optimization 1: Optimization for sequential access	RW	0B
19:18	CMD_IO	SPI Flash I/O Mode Selection for the Command Phase of a Read Transaction 00: Serial I/O (8 cycles) 01: Dual I/O (4 cycles) 10: Quad I/O (2 cycles) 11: Reserved	RW	00B
17:16	ADDR_IO	SPI Flash I/O Mode Selection for the Address Phase of a Read Transaction 00: Serial I/O (24 cycles) 01: Dual I/O (12 cycles) 10: Quad I/O (6 cycles) 11: Reserved	RW	00B
15:13	DUMMY_CYCLES	SPI Flash Inserted Dummy Cycles for the Dummy Cycle Phase of a Read Transaction 000: 0 cycles 001: 2 cycles 010: 4 cycles 011: 6 cycles 100: 8 cycles 101: 10 cycles 110: 12 cycles 111: 14 cycles	RW	000B
12:11	DATA_IO	SPI Flash I/O Mode Selection for the Data Phase of a Read Transaction (Assume 8*N Cycles) 00: Serial I/O (8*N cycles) 01: Dual I/O (4*N cycles) 10: Quad I/O (2*N cycles) 11: Reserved	RW	00B
10	HOLD_TILL_SFDR2	If this bit is '1', it indicates the write operation to this register (SFCR2) will not take effect immediately but will be delayed until another write operation to SFDR2.	RW	0B
9:0	Reserved	Reserved	-	-

6.4.7. SPI Flash Control and Status Register (SFCSR) (0xB800_1208)

This register does not provide byte access.

Table 10. SPI Flash Control and Status Register (SFCSR) (0xB800_1208)

Bit	Name	Description	Mode	Default
31	SPI_CSB0	SPI Flash Chip Select 0 (CS0#) 0: Active 1: Not active	RW	1B
30	SPI_CSB1	SPI Flash Chip Select 1 (CS1#) 0: Active 1: Not active	RW	1B
29:28	LEN	SPI Read/Write Data Length (Unit = byte) 00: 1 byte 01: 2 byte 10: 3 byte 11: 4 byte	RW	11B
27	SPI_RDY	SPI Flash Operation Busy Indication Flag 0: Busy (operation in progress) 1: Ready (idle or SPI access command is ready)	R	1B
26:25	IO_WIDTH	SPI Flash I/O Mode Selection of a Transaction 00: Serial I/O 01: Dual I/O 10: Quad I/O 11: Reserved	RW	00B
24	CHIP_SEL	Chip Selection 0: CS0# 1: CS1#	RW	0B
23:16	CMD_BYTE	SPI Flash 8-Bit Command Code of a Transaction This field is only used in Memory-Mapped I/O (MMIO) mode. Example: 'Read Data' is 0x03. 'Fast Read' is 0x0B.	RW	0B
15:0	Reserved	Reserved	-	-

6.4.8. SPI Flash Data Register (SFDR) (0xB800_120C)

This register does not provide byte access.

This configuration register is used under PIO (Programmed I/O) access mode.

Table 11. SPI Flash Data Register (SFDR) (0xB800_120C)

Bit	Name	Description	Mode	Default
31:24	Data3	Read/Write Data Byte 3	RW	0B
23:16	Data2	Read/Write Data Byte 2	RW	0B
15:8	Data1	Read/Write Data Byte 1	RW	0B
7:0	Data0	Read/Write Data Byte 0	RW	0B

6.4.9. SPI Flash Data Register 2 (SFDR2) (0xB800_1210)

This register does not provide byte access.

This configuration register is used under Memory-Mapped I/O (MMIO) access mode.

Table 12. SPI Flash Data Register 2 (SFDR2) (0xB800_1210)

Bit	Name	Description	Mode	Default
31:24	Data3	Read/Write Data Byte 3	RW	0B
23:16	Data2	Read/Write Data Byte 2	RW	0B
15:8	Data1	Read/Write Data Byte 1	RW	0B
7:0	Data0	Read/Write Data Byte 0	RW	0B

Realtek
CONFIDENTIAL
for ZTE CORPORATION

7. Peripheral and MISC Control

7.1. GPIO Control

The RTL8196C provides four sets of General Purpose Input/Output (GPIO) pins (GPIO A, B, C, D). Each GPIO pin may be configured as an input or output pin. The GPIO DATA register may be used to control GPIO pin signals. The GPIO pins are shared with some peripheral pins, and the type of peripheral can affect the attributes of the shared pins. All GPIO sets can be used to generate interrupts, and an interrupt mask and status register are provided. All the GPIO control registers are defined in the following tables.

7.1.1. GPIO Register Set (0xB800_3500)

Table 13. GPIO Register Set (0xB800_3500)

Offset	Size (byte)	Name	Description
0x00	4	PABCD_CNR	Port A, B, C, D Control Register
0x08	4	PABCD_DIR	Port A, B, C, D Direction Register
0x0C	4	PABCD_DAT	Port A, B, C, D Data Register
0x10	4	PABCD_ISR	Port A, B, C, D Interrupt Status Register
0x14	4	PAB_IMR	Port A, B Interrupt Mask Register
0x18	4	PCD_IMR	Port C, D Interrupt Mask Register

7.1.2. GPIO Port A, B, C, D Control Register (PABCD_CNR) (0xB800_3500)

Table 14. GPIO Port A, B, C, D Control Register (PABCD_CNR) (0xB800_3500)

Bit	Name	Description	RW	Default
31:24	PFC_D[7:0]	Pin Function Configuration of Port D	RW	FFH
23:16	PFC_C[7:0]	Pin Function Configuration of Port C	RW	FFH
15:8	PFC_B[7:0]	Pin Function Configuration of Port B	RW	FFH
7:0	PFC_A[7:0]	Pin Function Configuration of Port A Bit Value: 0: Configured as GPIO pin 1: Configured as dedicated peripheral pin	RW	FFH

7.1.3. GPIO Port A, B, C, D Direction Register (PABCD_DIR) (0xB800_3508)

Table 15. GPIO Port A, B, C, D Direction Register (PABCD_DIR) (0xB800_3508)

Bit	Name	Description	RW	Default
n.31-n.24	DRC_D[7:0]	Pin Direction Configuration of Port D 0: Configured as input pin 1: Configured as output pin	RW	00H
n.23-n.16	DRC_C[7:0]	Pin Direction Configuration of Port C 0: Configured as input pin 1: Configured as output pin	RW	00H
n.15-n.8	DRC_B[7:0]	Pin Direction Configuration of Port B 0: Configured as input pin 1: Configured as output pin	RW	00H
n.7-n.0	DRC_A[7:0]	Pin Direction Configuration of Port A 0: Configured as input pin 1: Configured as output pin	RW	00H

7.1.4. Port A, B, C, D Data Register (PABCD_DAT) (0xB800_350C)

Table 16. Port A, B, C, D Data Register (PABCD_DAT) (0xB800_350C)

Bit	Name	Description	RW	Default
n.31-n.24	PD_D[7:0]	Pin Data of Port D 0: Data=0 1: Data=1	RW	00H
n.23-n.16	PD_C[7:0]	Pin Data of Port C 0: Data=0 1: Data=1	RW	00H
n.15-n.8	PD_B[7:0]	Pin Data of Port B 0: Data=0 1: Data=1	RW	00H
n.7-n.0	PD_A[7:0]	Pin Data of Port A 0: Data=0 1: Data=1	RW	00H

7.1.5. Port A, B, C, D Interrupt Status Register (PABCD_ISR) (0xB800_3510)

Table 17. Port A, B, C, D Interrupt Status Register (PABCD_ISR) (0xB800_3510)

Bit	Name	Description	RW	Default
n.31-n.24	IPS_D[7:0]	Interrupt Pending Status of Port D Write '1' to clear the interrupt	RW	00H
n.23-n.16	IPS_C[7:0]	Interrupt Pending Status of Port C Write '1' to clear the interrupt	RW	00H
n.15-n.8	IPS_B[7:0]	Interrupt Pending Status of Port B Write '1' to clear the interrupt	RW	00H
n.7-n.0	IPS_A[7:0]	Interrupt Pending Status of Port A Write '1' to clear the interrupt	RW	00H

7.1.6. Port A, B Interrupt Mask Register (PAB_IMR) (0xB800_3514)

Table 18. Port A, B Interrupt Mask Register (PAB_IMR) (0xB800_3514)

Bit	Name	Description	RW	Default
n.31- n.30	PB7_IM[1:0]	PortB.7 Interrupt Mode	RW	00B
n.29- n.28	PB6_IM[1:0]	PortB.6 Interrupt Mode	RW	00B
n.27- n.26	PB5_IM[1:0]	PortB.5 Interrupt Mode	RW	00B
n.25- n.24	PB4_IM[1:0]	PortB.4 Interrupt Mode	RW	00B
n.23- n.22	PB3_IM[1:0]	PortB.3 Interrupt Mode	RW	00B
n.21- n.20	PB2_IM[1:0]	PortB.2 Interrupt Mode	RW	00B
n.19- n.18	PB1_IM[1:0]	PortB.1 Interrupt Mode	RW	00B
n.17- n.16	PB0_IM[1:0]	PortB.0 Interrupt Mode	RW	00B
n.15- n.14	PA7_IM[1:0]	PortA.7 Interrupt Mode	RW	00B
n.13- n.12	PA6_IM[1:0]	PortA.6 Interrupt Mode	RW	00B
n.11- n.10	PA5_IM[1:0]	PortA.5 Interrupt Mode	RW	00B
n.9- n.8	PA4_IM[1:0]	PortA.4 Interrupt Mode	RW	00B
n.7- n.6	PA3_IM[1:0]	PortA.3 Interrupt Mode	RW	00B
n.5- n.4	PA2_IM[1:0]	PortA.2 Interrupt Mode	RW	00B

Bit	Name	Description	RW	Default
n.3-n.2	PA1_IM[1:0]	PortA.1 Interrupt Mode	RW	00B
n.1-n.0	PA0_IM[1:0]	PortA.0 Interrupt Mode 00: Disable interrupt 01: Enable falling edge interrupt 10: Enable rising edge interrupt 11: Enable both falling or rising edge interrupt	RW	00B

7.1.7. Port C, D Interrupt Mask Register (PCD_IMR) (0xB800_3518)

Table 19. Port C, D Interrupt Mask Register (PCD_IMR) (0xB800_3518)

Bit	Name	Description	RW	Default
n.31- n.30	PD7_IM[1:0]	PortD.7 Interrupt Mode	RW	00B
n.29- n.28	PD6_IM[1:0]	PortD.6 Interrupt Mode	RW	00B
n.27- n.26	PD5_IM[1:0]	PortD.5 Interrupt Mode	RW	00B
n.25- n.24	PD4_IM[1:0]	PortD.4 Interrupt Mode	RW	00B
n.23- n.22	PD3_IM[1:0]	PortD.3 Interrupt Mode	RW	00B
n.21- n.20	PD2_IM[1:0]	PortD.2 Interrupt Mode	RW	00B
n.19- n.18	PD1_IM[1:0]	PortD.1 Interrupt Mode	RW	00B
n.17- n.16	PD0_IM[1:0]	PortC.0 Interrupt Mode	RW	00B
n.15- n.14	PC7_IM[1:0]	PortC.7 Interrupt Mode	RW	00B
n.13- n.12	PC6_IM[1:0]	PortC.6 Interrupt Mode	RW	00B
n.11- n.10	PC5_IM[1:0]	PortC.5 Interrupt Mode	RW	00B
n.9- n.8	PC4_IM[1:0]	PortC.4 Interrupt Mode	RW	00B
n.7- n.6	PC3_IM[1:0]	PortC.3 Interrupt Mode	RW	00B
n.5- n.4	PC2_IM[1:0]	PortC.2 Interrupt Mode	RW	00B
n.3- n.2	PC1_IM[1:0]	PortC.1 Interrupt Mode	RW	00B
n.1- n.0	PC0_IM[1:0]	PortC.0 Interrupt Mode 00: Disable interrupt 01: Enable falling edge interrupt 10: Enable rising edge interrupt 11: Enable both falling or rising edge interrupt	RW	00B

7.2. GPIO Shared Pin Mapping List

The RTL8196C GPIO pins are shared with other functions.

Table 20. Shared Pin Register (PIN_MUX_SEL) (0xB800_0040)

Bit	Bit Name	Description	RW	Default
31:24	Reserved	Reserved	-	-
23	reg_iocfg_pcie	Configure PCIE_RST# as PCIE_RST# or GPIO 0: PCIE_RST# 1: GPIOB1	RW	2'b0
22	reg_iocfg_uart	Configure UART Pins as UART, DBG, or GPIO Mode 0: UART 1: GPIOA7 and GPIOB0	RW	2'b0

Bit	Bit Name	Description	RW	Default
21:20	reg_iocfg_jtag	Configure JTAG Pins as JTAG, DBG, or GPIO Mode 0x: JTAG 10: DBG mode 11: GPIOA[6:2]	RW	2'b00
19:18	reg_iocfg_mem	Configure Flash/DRAM CS1# as Flash/DRAM CS1#, DRAM CKE, DBG, or GPIO Mode 00: NF_CS1#/MCS1# 01: DRAM CKE 10: DBG mode 11: GPIOA[1:0]	RW	2'b00
17:14	Reserved	Reserved	-	-
13:12	reg_iocfg_led_p2	Configure LEDPHASE2 Pin as DBG or GPIO Mode 0x: Reserved 10: DBG mode 11: GPIOC0	RW	2'b00
11:10	reg_iocfg_led_p1	Configure LEDPHASE1 Pin as DBG or GPIO Mode 0x: Reserved 10: DBG mode 11: GPIOB7	RW	2'b00
9:8	reg_iocfg_led_p0	Configure LEDPHASE0 Pin as LED-SW, DBG, or GPIO Mode 0x: LED_PORT4 10: DBG mode 11: GPIOC6	RW	3'b000
7:6	reg_iocfg_led_s3	Configure LEDSIG3 Pin as LED-SW, DBG, or GPIO Mode 0x: LED_PORT3 10: DBG mode 11: GPIOB5	RW	2'b00
5:4	reg_iocfg_led_s2	Configure LEDSIG2 Pin as LED-SW, DBG, or GPIO Mode 0x: LED_PORT2 10: DBG mode 11: GPIOB4	RW	2'b00
3:2	reg_iocfg_led_s1	Configure LEDSIG1 Pin as LED-SW, DBG, or GPIO Mode 0x: LED_PORT1 10: DBG mode 11: GPIOB3	RW	2'b00
1:0	reg_iocfg_led_s0	Configure LEDSIG0 Pin as LED-SW, DBG, or GPIO Mode 0x: LED_PORT0 10: DBG mode 11: GPIOB2	RW	2'b00

8. Green Ethernet

8.1. Cable Length Power Saving

The RTL8196C provides link-on and dynamic detection of cable length, and dynamic adjustment of power required for the detected cable length. This feature provides high performance with minimum power consumption.

8.2. Link Down Power Saving

The RTL8196C implements link-down power saving on a per-port basis, greatly cutting power consumption when the network cable is disconnected. A port automatically enters link down power saving mode ten seconds after the cable is disconnected from it. Once a port enters link down power saving mode, it transmits normal link pulses on its TXOP/TXON pins and continues to monitor the RXIP/RXIN pins to detect incoming signals, which might be 100Base-TX MLT-3 idle pattern, 10Base-T link pulses, or Auto-Negotiation's FLP (Fast Link Pulse). After it detects an incoming signal, it wakes up from link down power saving mode and operates in normal mode according to the result of the connection.

8.3. Energy Efficient Ethernet (EEE)

The RTL8196C supports IEEE 802.3az Draft 2.0, also known as Energy Efficient Ethernet (EEE) in 100Base-TX in full duplex operation, and 10Base-T in full/half duplex mode. This standard is being developed by the IEEE 802.3az Task Force, and should be finalized by September 2010. It provides a protocol to coordinate transitions to/from a lower power consumption level (Low Power Idle mode) based on link utilization. When no packets are being transmitted, the system goes to Low Power Idle mode to save power. Once packets need to be transmitted, the system returns to normal mode, and does this without changing the link status and without dropping/corrupting frames.

To save power, when the system is in Low Power Idle mode, most of the circuits are disabled, however, the transition time to/from Low Power Idle mode is kept small enough to be transparent to upper layer protocols and applications.

EEE also specifies a negotiation method to enable link partners to determine whether EEE is supported and to select the best set of parameters common to both devices.

- For 100Base-TX PHY: Supports Energy Efficient Ethernet with the optional function of Low Power Idle.
- For 10Base-T, EEE defines a 10Mbps PHY (10Base-Te) with reduced transmit amplitude requirements. 10Base-Te is fully interoperable with 10Base-T PHYs over 100m of class-D (Cat-5) cable.

Refer to <http://ieee802.org/3/interims/index.html> for more details.

9. DC Specifications

9.1. Operating Conditions

Table 21. Operating Conditions

Symbol	Parameter	Min.	Typ.	Max.	Units
VDD33	Digital I/O Power Supply 3.3V	TBD	TBD	TBD	V
AVDD33	Ethernet Analog Power Supply 3.3V	TBD	TBD	TBD	V
VDD10	Core Power Supply 1.0V	TBD	TBD	TBD	V
AVDD10	Ethernet Analog Power Supply 1.0V	TBD	TBD	TBD	V
AVDD33_X25M	25M Crystal Power 3.3V	TBD	TBD	TBD	V
VDD33_BG	System Bandgap Power Supply 3.3V	TBD	TBD	TBD	V
AVDD10_PCIE	PCI Express Analog Power 1.0V	TBD	TBD	TBD	V
AVDD10_PHYPLL	Ethernet PHY PLL Power 1.0V	TBD	TBD	TBD	V
AVDD33_USB_PCIE	USB 2.0 Analog Power 3.3V	TBD	TBD	TBD	V
AVDD10_USB	USB 2.0 Analog Power 1.0V	TBD	TBD	TBD	V

9.2. Power Dissipation

Table 22. Power Dissipation

Parameter	SYM	Conditions	Min	Typ.	Max	Units
Power Supply Current for VDD33	I _{VDD33}	All LAN Ports Idle	-	TBD	-	mA
		LAN Full Load Active for Link at 10Base-T	-	TBD	-	
		LAN Full Load Active for Link at 100Base-TX	-	TBD	-	
Power Supply Current for VDD10	I _{VDD10}	All LAN Ports Idle and CPU Suspend	-	TBD	-	mA
		All LAN Ports Idle	-	TBD	-	
		LAN Full Load Active for Link at 10Base-T	-	TBD	-	
		LAN Full Load Active for Link at 100Base-TX	-	TBD	-	
3.3V Ethernet Analog Current for AVDD33	I _{AVDD33}	All LAN Ports Idle	-	TBD	-	mA
		LAN Full Load Active for Link at 10Base-T	-	TBD	-	
		LAN Full Load Active for Link at 100Base-TX	-	TBD	-	
1.0V Ethernet Analog Current for AVDD10	I _{AVDD10}	All LAN Ports Idle	-	TBD	-	mA
		LAN Full Load Active for Link at 10Base-T	-	TBD	-	
		LAN Full Load Active for Link at 100Base-TX	-	TBD	-	
3.3V Current for AVDD33_X25M	I _{AVDDX}	25M Crystal 3.3V Current	-	TBD	-	mA
3.3V Current for AVDD33_BG	I _{AVDDBG}	System Bandgap 3.3V Current	-	TBD	-	mA
1.0V Current for AVDD10_PCIE	I _{PCIE}	PCI Express 1.0V Current	-	TBD	-	mA
1.0V Current for AVDD10_PHYPLL	I _{PHYPLL}	Ethernet PHY PLL Power 1.0V	-	TBD	-	mA
3.3V Current for AVDD33_USB_PCIE	I _{USB_AVDD33}	USB 2.0 and PCI Express Analog Power 3.3V	-	TBD		mA
1.0V Current for AVDD10_USB	I _{LV_USB_PCIE}	USB 2.0 Analog Power 1.0V	-	TBD	-	mA

Parameter	SYM	Conditions	Min	Typ.	Max	Units
Total Power Consumption	PS	All LAN Ports Idle and CPU Suspended	-	TBD	-	Watt
		All LAN Ports Idle	-	TBD	-	
		LAN Full Load Active for Link at 10Base-T	-	TBD	-	
		LAN Full Load Active for Link at 100Base-TX	-	TBD	-	

Note: The power consumption is measured at full load of the chip system with the operating condition of: CPU=330MHz, SDRAM=162MHz.

9.3. SDRAM Bus DC Parameters

Table 23. SDRAM Bus DC Parameters

Symbol	Parameter	Conditions	Min.	Typ.	Max.	Units	Notes
V _{IH}	Input-High Voltage	LVTTL	TBD	-	-	V	1
V _{IL}	Input-Low Voltage	LVTTL	-	-	TBD	V	2
V _{OH}	Output-High Voltage	-	TBD	-	-	V	3
V _{OL}	Output-Low Voltage	-	-	-	TBD	V	3
I _{IL}	Input-Leakage Current	V _{IN} =3.3V or 0	TBD	±1	TBD	μA	-
I _{OZ}	Tri-State Output-Leakage Current	-	TBD	±1	TBD	μA	-
R _{PU}	Input Pull-Up Resistance	-	-	TBD	-	KΩ	4
R _{PD}	Input Pull-Down Resistance	-	-	TBD	-	KΩ	4

Note 1: V_{IH} overshoot: V_{IH} (MAX)=V_{VDDH} + 2V for a pulse width ≤ 3ns, and the pulse width not greater than one third of the cycle rate.

Note 2: V_{IL} undershoot: V_{IL} (MIN)=-2V for a pulse width ≤ 3ns cannot be exceeded.

Note 3: The output current buffer is 16mA for SDRAM clock, address, and data bus.

Note 4: These values are typical values checked in the manufacturing process and are not tested.

9.4. Flash Bus DC Parameters

Table 24. Flash Bus DC Parameters

Symbol	Parameter	Conditions	Min.	Typ.	Max.	Units	Notes
V _{IH}	Input-High Voltage	LVTTL	TBD	-	-	V	1
V _{IL}	Input-Low Voltage	LVTTL	-	-	TBD	V	2
V _{OH}	Output-High Voltage	-	TBD	-	-	V	3
V _{OL}	Output-Low Voltage	-	-	-	TBD	V	3
I _{IL}	Input-Leakage Current	V _{IN} =3.3V or 0	TBD	±1	TBD	μA	-
I _{OZ}	Tri-State Output-Leakage Current	-	TBD	±1	TBD	μA	-
R _{PU}	Input Pull-Up Resistance	-	-	TBD	-	KΩ	4
R _{PD}	Input Pull-Down Resistance	-	-	TBD	-	KΩ	4

Note 1: V_{IH} overshoot: V_{IH} (MAX)=V_{VDDH} + 2V for a pulse width ≤ 3ns.

Note 2: V_{IL} undershoot: V_{IL} (MIN)= -2V for a pulse width ≤ 3ns.

Note 3: The output current buffer is 8mA for the flash address and data bus; and is 8mA for Flash control signals.

Note 4: These values are typical values checked in the manufacturing process and are not tested.

9.5. USB 1.1 DC Parameters

Table 25. USB 1.1 DC Parameters

Symbol	Parameter	Conditions	Min.	Typ.	Max.	Units	Notes
V _{IH}	Input-High Voltage	-	TBD	-	-	V	2
V _{IL}	Input-Low Voltage	-	-	-	TBD	V	2
V _{OH}	Output-High Voltage	-	TBD	-	-	V	2
V _{OL}	Output-Low Voltage	-	-	-	TBD	V	2
I _{IL}	Input-Leakage Current	V _{IN} =3.3V or 0	-	-	-	μA	1

Note 1: These values are typical values checked in the manufacturing process and are not tested.

Note 2: For additional information, see the USB 1.1 Specification.

9.6. USB 2.0 DC Parameters

Table 26. USB 2.0 DC Parameters

Symbol	Parameter	Conditions	Min.	Typ.	Max.	Units	Notes
V _{IH}	Input-High Voltage	-	TBD	-	-	mV	2
V _{IL}	Input-Low Voltage	-	-	-	TBD	mV	2
V _{OH}	Output-High Voltage	-	TBD	-	TBD	mV	2
V _{OL}	Output-Low Voltage	-	TBD	-	TBD	mV	2
I _{IL}	Input-Leakage Current	-	-	-	-	μA	1

Note 1: These values are typical values checked in the manufacturing process and are not tested.

Note 2: For additional information, see the USB 2.0 Specifications.

9.7. UART DC Parameters

Table 27. UART DC Parameters

Symbol	Parameter	Conditions	Min.	Typ.	Max.	Units	Notes
V _{IH}	Input-High Voltage	LVTTL	TBD	-	-	V	-
V _{IL}	Input-Low Voltage	LVTTL	TBD	-	TBD	V	-
V _{OH}	Output-High Voltage	-	TBD	-	TBD	V	1
V _{OL}	Output-Low Voltage	-	TBD	-	TBD	V	1
I _{IL}	Input-Leakage Current	V _{IN} =3.3V or 0	TBD	TBD	TBD	μA	2
R _{PU}	Input Pull-Up Resistance	-	-	TBD	-	KΩ	2
R _{PD}	Input Pull-Down Resistance	-	-	TBD	-	KΩ	2

Note 1: The output current buffer is 8mA for UART related signals.

Note 2: These values are typical values checked in the manufacturing process and are not tested.

9.8. GPIO DC Parameters

Table 28. GPIO DC Parameters

Symbol	Parameter	Conditions	Min.	Typ.	Max.	Units	Notes
V _{IH}	Input-High Voltage	LVTTL	TBD	-	-	V	-
V _{IL}	Input-Low Voltage	LVTTL	TBD	-	TBD	V	-
V _{OH}	Output-High Voltage	-	TBD	-	TBD	V	1
V _{OL}	Output-Low Voltage	-	TBD	-	TBD	V	1
I _{IL}	Input-Leakage Current	-	TBD	TBD	TBD	μA	2
R _{PD}	Input Pull-Down Resistance	-	-	TBD	-	KΩ	2

Note 1: The output current buffer is 8mA for GPIO related signals.

Note 2: These values are typical values checked in the manufacturing process and are not tested.

9.9. JTAG DC Parameters

Table 29. JTAG DC Parameters

Symbol	Parameter	Conditions	Min.	Typ.	Max.	Units	Notes
V _{IH}	Input-High Voltage	LVTTL	TBD	TBD	TBD	V	-
V _{IL}	Input-Low Voltage	LVTTL	TBD	TBD	TBD	V	-
V _{OH}	Output-High Voltage	I _{OH} =2~16mA	TBD	TBD	TBD	V	1
V _{OL}	Output-Low Voltage	I _{OL} =2~16mA	TBD	TBD	TBD	V	1
I _{IL}	Input-Leakage Current	-	TBD	TBD	TBD	μA	2
R _{PD}	Input Pull-Down Resistance	-	TBD	TBD	TBD	KΩ	2

Note 1: The output current buffer is 8mA for JTAG related signals.

Note 2: These values are typical values checked in the manufacturing process and are not tested.

9.10. LED DC Parameters

Table 30. LED DC Parameters

Symbol	Parameter	Conditions	Min.	Typ.	Max.	Units
V _{OHED}	Output-High Voltage	-	TBD	TBD	TBD	V
V _{OLLED}	Output-Low Voltage	-	TBD	TBD	TBD	V

Note: The output current buffer for LED signals is 8mA.

10. AC Specifications

10.1. Clock Signal Timing

Table 31. Clock Signal Timing

Symbol	Parameter	Min.	Typ.	Max.	Units	Notes
V_{IH}	Input-High Voltage	TBD	TBD	TBD	V	-
V_{IL}	Input-Low Voltage	TBD	TBD	TBD	V	-
$T_{FREQUENCY}$	Clock Frequency for RTL8196C Crystal or Oscillator	TBD	TBD	TBD	MHz	1
$\Delta_{FREQUENCY}$	Clock Tolerance (between 0°C~50°C)	TBD	TBD	TBD	ppm	-
C_{SHUNT}	Crystal Parameter <i>Note: Sometimes referred to as the Holder Capacitance.</i>	TBD	TBD	TBD	pF	2
C_1	Load Capacitance	TBD	TBD	TBD	pF	3
C_2	Load Capacitance	TBD	TBD	TBD	pF	3
T_{DC}	Duty Cycle <i>Note: This parameter applies when driving the clock input with an oscillator.</i>	TBD	TBD	TBD	%	-

Note 1: This value could be an oscillator input or a series resonant frequency from a crystal. If used as an oscillator input, tie to the crystal input pin and leave the crystal output pin disconnected.

Note 2: The 25MHz Crystal $CL=16pF$ is used on the RTL8196C.

Note 3: The RTL8196C PLL circuit requires an external 25MHz crystal with shunt capacitors. These shunt capacitors cannot be over 30pF due to chip design requirements.

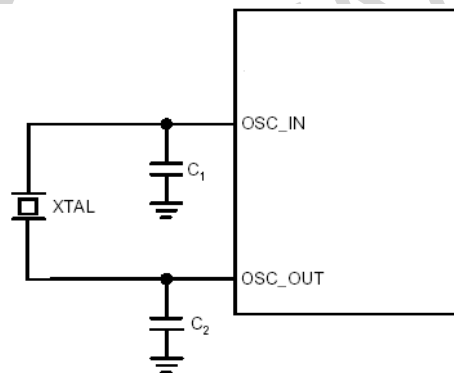
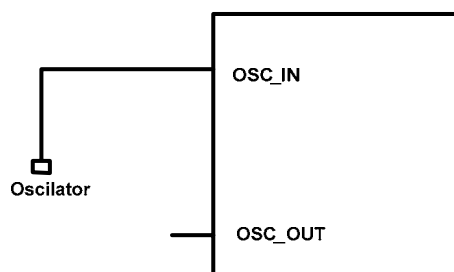
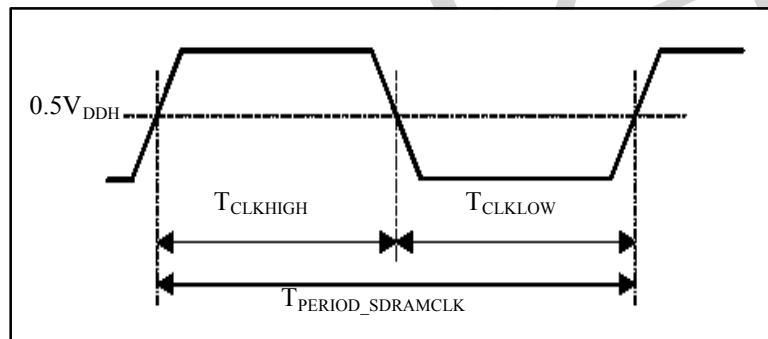
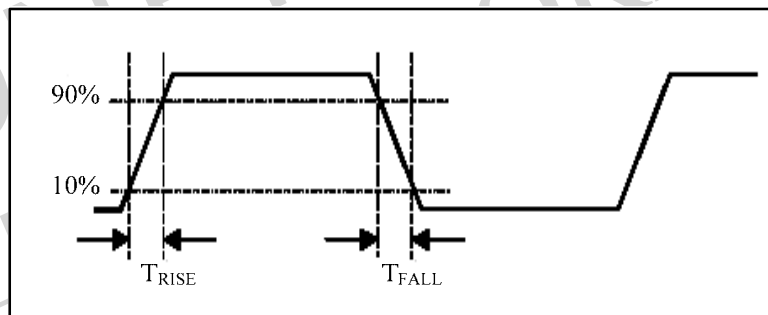

Figure 4. Typical Connection to a Crystal

Figure 5. Typical Connection to an Oscillator

10.1.1. SDRAM Clock Timing

Table 32. SDRAM Clock Timing

Symbol	Parameter	130~180MHz			Units	Notes
		Min. (130MHz)	Typ. (160MHz)	Max. (180MHz)		
$T_{PERIOD_SDRAMCLK}$	Clock Period for SDRAM Clock	TBD	TBD	TBD	ns	-
$T_{CLKHIGH}$	SDRAM Clock High Time	TBD	TBD	TBD	ns	-
T_{CLKLOW}	SDRAM Clock Low Time	TBD	TBD	TBD	ns	-
$T_{RISE/FALL}$	Rising and Falling Time Requirements for SDRAM Clock	TBD	TBD	TBD	ns	-
$T_{RISE/FALL_OUTPUT}$	Propagation Delay for Output Rising and Falling	TBD	TBD	TBD	ns	1

Note 1: Please contact Realtek for the IBIS model.

Figure 6. SDRAM Clock Specifications-1

Figure 7. SDRAM Clock Specifications-2

10.2. Bus Signal Timing

10.2.1. SDRAM Bus

10.2.1.1 SDRAM Input Timing

Table 33. SDRAM Input Timing

Symbol	Parameter	Min.	Typ.	Max.	Units
T_{SETUP}	Input setup prior to rising edge of clock. Inputs included in this timing are D[31:0] (during a read operation)	TBD	TBD	-	ns
T_{HOLD}	Input hold time after the rising edge of clock. Inputs included in this timing are D[31:0] (during a read operation)	TBD	TBD	-	ns

Note: The RTL8196C integrates some timing controls on the interface. Here the timing parameters listed in the table are extracted in the default situation (without specific controls).

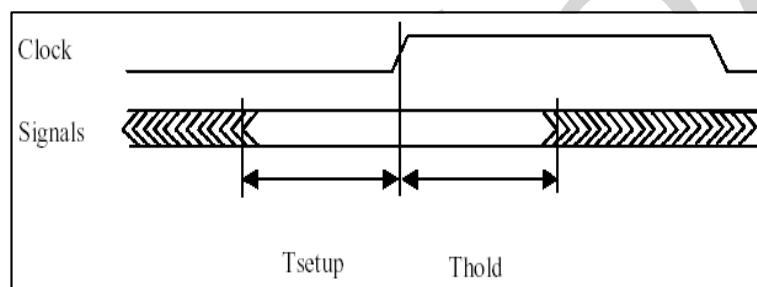
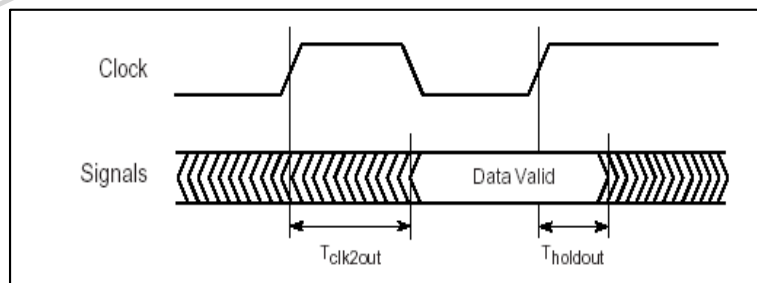

Figure 8. SDRAM Input Timing

10.2.1.2 SDRAM Output Timing

Table 34. SDRAM Output Timing

Symbol	Parameter	Min.	Typ.	Max.	Units
T_{CLK2OUT}	Rising edge of clock-to-signal output. Outputs included in this timing are D[31:0], CS0#, CS1#, RAS#, CAS#, LDQM, UDQM, WE# (during a write operation)	TBD	TBD	TBD	ns
T_{HOLDOUT}	Signal output hold time after the rising edge of the clock. Outputs included in this timing are D[31:0] (during a write operation)	TBD	TBD	TBD	ns

Note: The RTL8196C integrates some timing controls on the interface. Here the timing parameters listed in the table are extracted in the default situation (without specific controls).

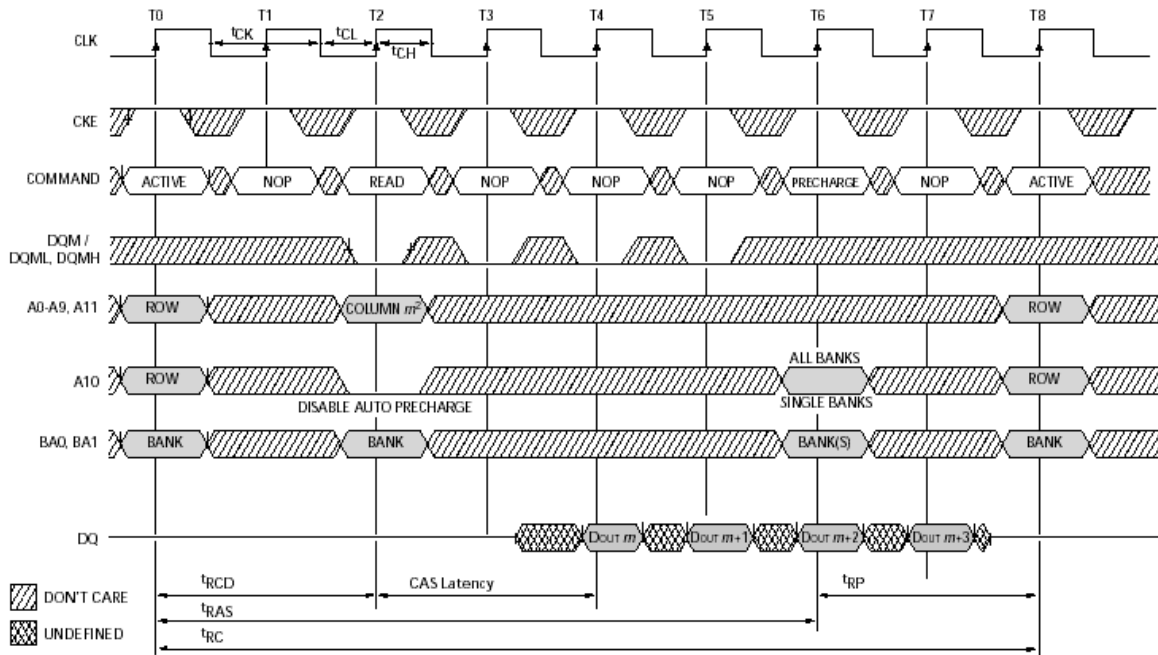

Figure 9. SDRAM Output Timing

10.2.1.3 SDRAM Access Control Timing

Table 35. SDRAM Access Control Timing

Symbol	Parameter	Units	Notes
$T_{REFRESH}$	Auto-Refresh Timing Controlled by Reg. 0xB8001008 (DTR)	μ S	-
T_{RCD}	The Time Interval between RAS# Active and CAS# Active Controlled by Reg. 0xB8001008 (DTR)	ns	-
T_{RP}	The Time Interval between Pre-Charge and the Next Active Controlled by Reg. 0xB8001008 (DTR)	ns	-
T_{RAS}	The Time Interval between Active and Pre-Charge Controlled by Reg. 0xB8001008 (DTR)	ns	-
T_{RC}	The Time Interval between Active and the Next Active Controlled by Reg. 0xB8001008 (DTR)	ns	1
T_{RFC}	The Time Interval between Auto-Refresh and Active Controlled by Reg. 0xB8001008 (DTR)	ns	-
$T_{CAS_LATENCY}$	The Data Output Delay after CAS# Active Controlled by Reg. 0xB8001004 (DCR)	ns	-

Note 1: $TRC = TRAS + TRP$

Figure 10. SDRAM Access Control Timing

10.2.2. Flash Bus

Table 36. Flash Access Timing Values

Symbol	Parameter	Min.	Typ.	Max.	Units
T_{CS}	The Timing Interval between NF_CS0# (or NF_CS1#) and WE#	Controlled by Reg. 0xB8001100 (NFCR)			ns
T_{WP}	The Timing Interval for WE# to be Pulled Low (RAS# for Read Operation)	Controlled by Reg. 0xB8001100 (NFCR)			ns

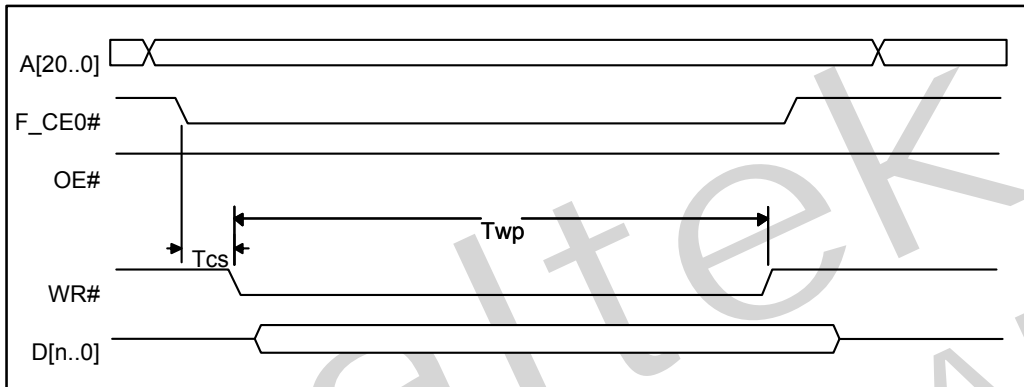
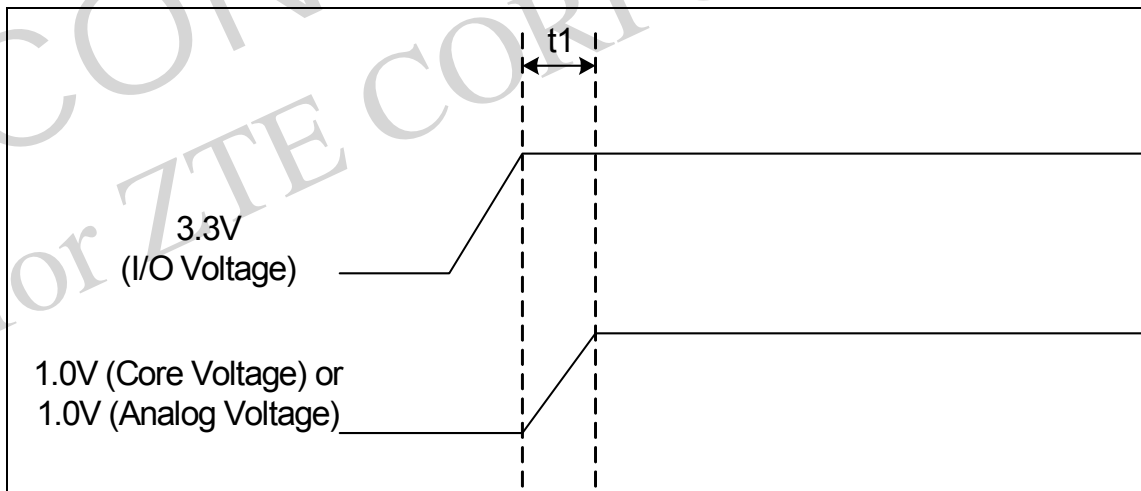

Figure 11. Flash Access Timing

10.2.3. Power Sequence

Table 37. Power-Up Timing Parameters

Symbol	Parameter	Min.	Typ.	Max.	Units
t1	3.3V Stable to 1.0V	1	-	-	ms

Note: The 3.3V (I/O) must be powered up before 1.0V (core) and 1.0V (analog) voltage.

Figure 12. Power Up Sequence Timing Diagram

10.2.4. Power Configuration Timing

Power up configuration only relates to internal timing. The external hardware pin reset is irrelevant with regard to power up configuration. The Hardware reset pin is valid when an internal reset ends the active state.

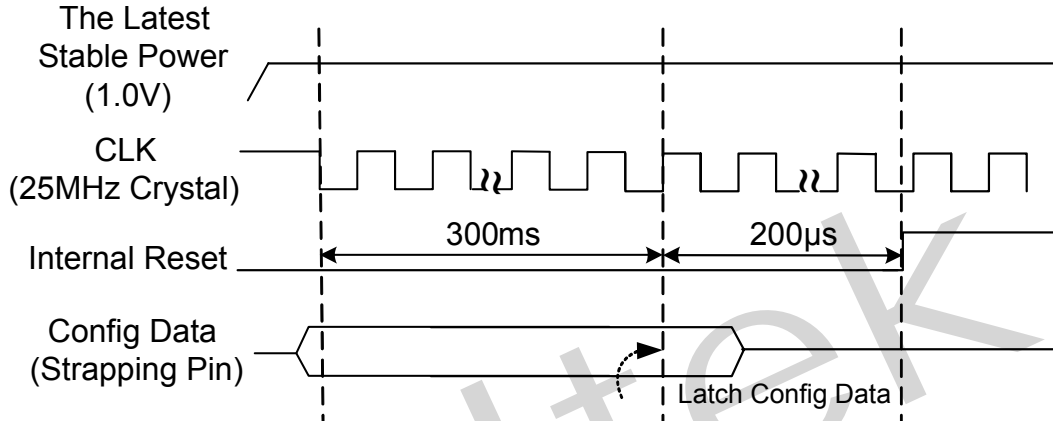

Figure 13. Power Up Configuration Timing Diagram

Realtek
 CONFIDENTIAL
 for ZTE CORPORATION

11. Thermal Characteristics

Heat generated by the chip causes a temperature rise of the package. If the temperature of the chip (T_j , junction temperature) is beyond the design limits, there will be negative effects on operation and the life of the IC package. Heat dissipation, either through a heat sink or electrical fan, is necessary to provide a reasonable environment (T_a , ambient temperature) in a closed case. As power density increases, thermal management becomes more critical. A method to estimate the possible T_a is outlined below.

Thermal parameters are defined as below according to JEDEC standard JESD 51-2, 51-6:

(1) θ_{ja} (Thermal resistance from junction to ambient), represents resistance to heat flow from the chip to ambient air. This is an index of heat dissipation capability. A lower θ_{ja} means better thermal performance.

$$\theta_{ja} = (T_j - T_a) / P$$

Where T_j is the die junction temperature, T_a is the ambient air temperature

P is the power dissipation by device (Watts)

(2) θ_{jc} (Thermal Resistance Junction-to-Case, °C/W), measures the heat flow resistance between the die surface and the surface of the package (case). This data is relevant for packages used with external heat sinks.

$$\theta_{jc} = (T_j - T_c) / P$$

Where T_j is the die junction temperature, T_c is the package case temperature

P is the power dissipation by device (Watts)

(3) Ψ_{jt} (Thermal Characterization Parameter: Junction to package top), represents the correlation between the temperature of the chip and the package top.

$$\Psi_{jt} = (T_j - T_t) / P$$

Where T_j is the die junction temperature, T_t is the top of package temperature

P is the power dissipation by device (Watts)

Thermal Terminology

The major thermal dissipation paths can be illustrated as follows:

T_j: The maximum junction temperature

T_a: The ambient or environment temperature

T_c: The maximum compound surface temperature

T_b: The maximum surface temperature of PCB bottom

P: Total input power

PQFP Junction to ambient thermal resistance, θ_{JA} , defined as:

$$\theta_{JA} = \frac{T_J - T_A}{P}$$

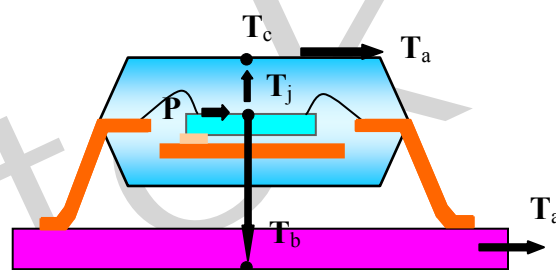

Thermal Dissipation of PQFP Package

11.1. Thermal Operating Range

Table 38. Thermal Operating Range

Parameter	SYM	Condition	Min	Typical	Max	Units
Junction Operating Temperature	T _j	-	TBD	TBD	TBD	°C
Ambient Operating Temperature	T _a	4-layer FR4 PCB (without head sink)	TBD	TBD	TBD	°C

Note: PCB conditions (JEDEC JESD51-7). Dimensions: 7.62mm x 11.43mm. Thickness: 1.6mm.

11.2. RTL8196C Thermal Parameters

Table 39. RTL8196C Thermal Parameters

Parameter	SYM	Condition	Air Flow 0 m/s	Air Flow 1 m/s	Air Flow 2 m/s	Air Flow 3 m/s	Units
Thermal Resistance: Junction to ambient	θ_{ja}	2-layer FR4 PCB	TBD	TBD	TBD	TBD	°C/W
Thermal Resistance: Junction to ambient	θ_{ja}	4-layer FR4 PCB	TBD	TBD	TBD	TBD	°C/W
Thermal Characterization: Junction to package top	Ψ_{jt}	2-layer FR4 PCB	TBD	TBD	TBD	TBD	°C/W
Thermal Characterization: Junction to package top	Ψ_{jt}	4-layer FR4 PCB	TBD	TBD	TBD	TBD	°C/W

Note: PCB conditions (JEDEC JESD51-7). Dimensions: 7.62mm x 11.43mm; Thickness: 1.6mm.

12. Mechanical Dimensions

12.1. Plastic Quad Flat Package 128-Pin 14x20mm Outline

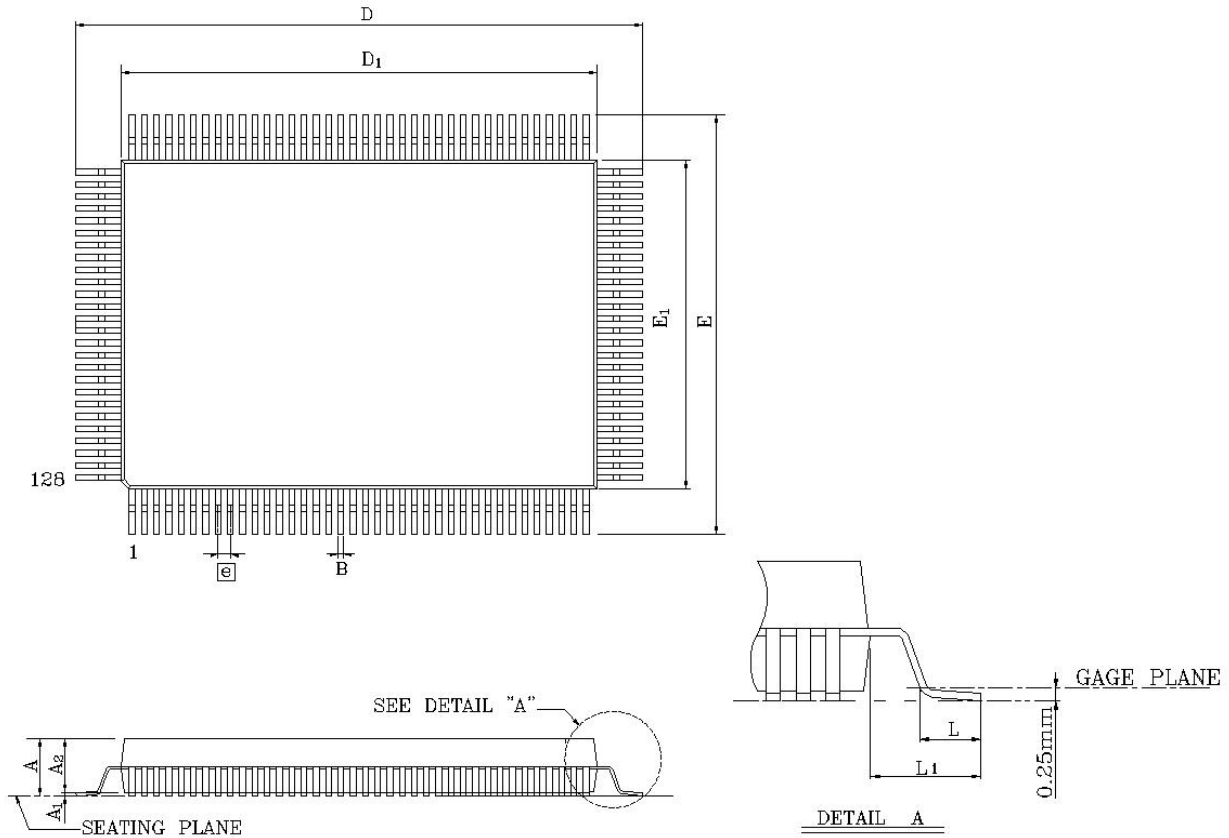

Symbol	Dimension in mm			Dimension in inch		
	Min	Nom	Max	Min	Nom	Max
A	-	-	3.40	-	-	0.134
A ₁	0.25	-	-	0.010	-	-
A ₂	2.50	2.70	2.90	0.100	0.106	0.114
b	0.17	0.22	0.27	0.007	0.009	0.011
D	23.2BSC			0.913BSC		
D ₁	20.00BSC			0.787BSC		
E	17.20BSC			0.677BSC		
E ₁	14.00BSC			0.551BSC		
e	0.50BSC			0.020BSC		
L	0.73	0.88	1.03	0.029	0.035	0.041
L ₁	1.60REF			0.063REF		

Notes: CONTROLLING DIMENSION: MILLIMETER (mm).

13. Ordering Information

Table 40. Ordering Information

Part Number	Package	Status
RTL8196C-GR	128-Pin PQFP, 'Green' Package	

Note: See page 5 for package and version identification.

Realtek
CONFIDENTIAL
for ZTE CORPORATION

Realtek Semiconductor Corp.**Headquarters**

No. 2, Innovation Road II

Hsinchu Science Park, Hsinchu, 300, Taiwan, R.O.C.

Tel.: +886-3-578-0211. Fax: +886-3-577-6047

www.realtek.com